

ST6560-T3 3axis mach3 cnc Stepper Motor Controller operation instruction

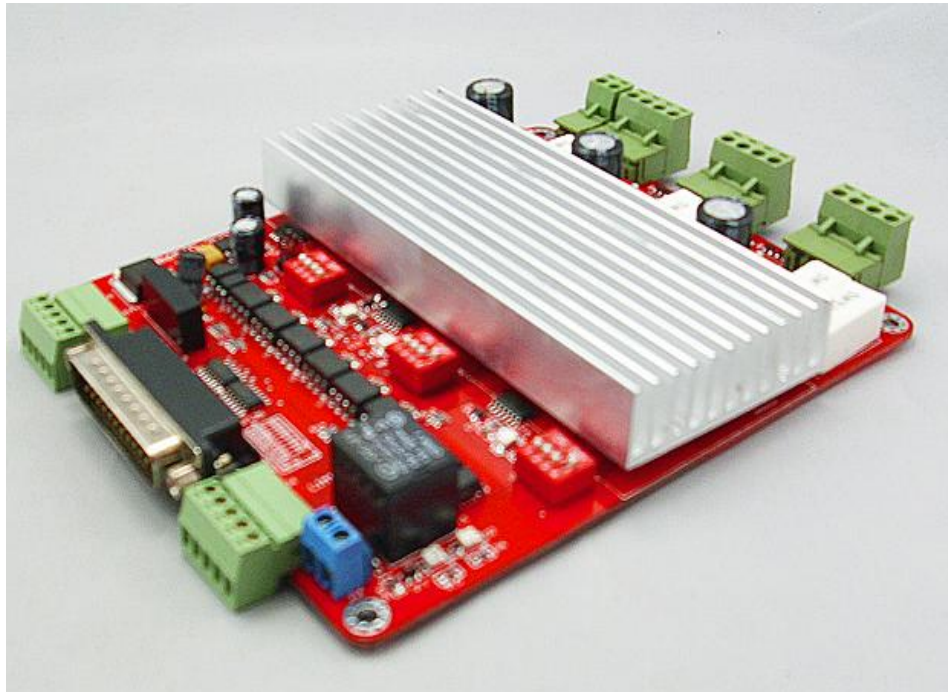

Content

ST6560-T3 3axis mach3 cnc Stepper Motor Controller operation instruction	1
I. features of ST6560-T3.....	3
II、Applications:	3
III、Electrical drawing.....	4
V. Definition on pins of parallel port.....	4
VII.Limit switch connection	6
VIII. Adjusting current decay、microstep resolution、current output	7
1. Current decay adjustment	7
3、Current setting.....	9
IX. stepper motor Connection.....	9
X.The choice of stepper motors and its power	10
XI、Usage of MACH3.....	12
1、Startup Mach3.....	12
3、Adjusting limits witch of mach3.....	15
4、Running of G code.....	16
5、How to use the manual control interface of MACH3	18

I. features of ST6560-T3

- ◆ It Can drive 3 stepper motor running at the same time, the 4th axis also can be added, if you need to extend it ;
- ◆ It has High-speed photoelectric coupler and DCDC (dc isolation module), Can strongly protect your computer not to be damaged;
- u One relay, it can be used to control spindle start and stop;
- u standstill current automatically reduced to 50% of the selected dynamic current one second after the last pulse,;
- u 4 axis 0.8-3.5A (peak) adjustable current、 four running mode、 microstep resolution (1、 1 / 2、 1 / 8、 1 / 16);
- u Interface with Standard parallel port , support MACH3 or other parallel port software;
- ◆ Four input port, Can connect to the limit switch, emergency stop, or other Input devices;
- u Power supply voltage : 12-36VDC。

II 、 Applications:

Suitable for a wide range of stepping motors, from size 39mm to 57mm. It can be used in various kinds of machines, such as engraving machines, laser cutters ,and so on.

III、 Electrical drawing

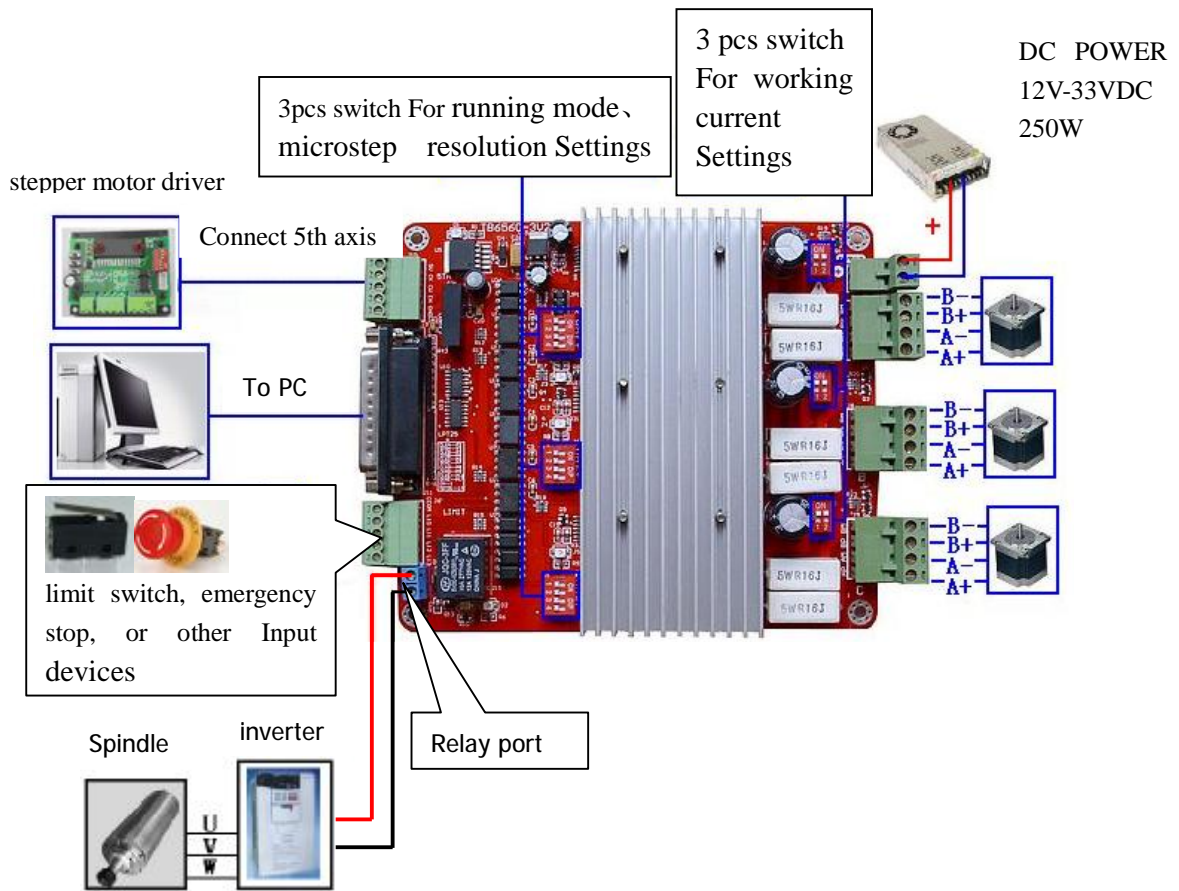

V. Definition on pins of parallel port

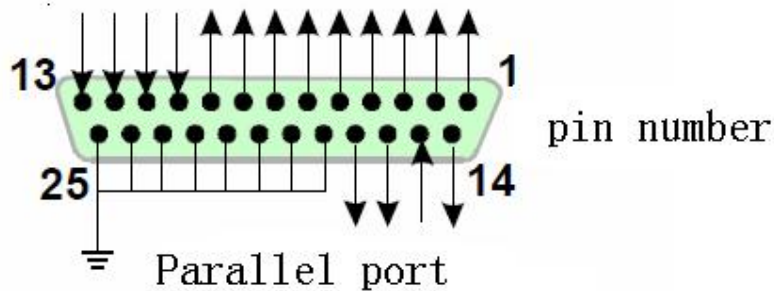

Fig.2

25-pin parallel port control is defined as follows:

DB25 PIN	The role of the pin on driver board	notes
1	EN	Enable all axis
2	STEPX	X pulse signal
3	DIRX	X direction signal
4	STEPY	Y pulse signal
5	DIRY	Y direction signal
6	STEPZ	Z pulse signal
7	DIRZ	Z direction signal
10	LIMIT-1	X axis Limit
11	LIMIT-2	Y axis Limit
12	LIMIT-3	Z axis Limit
13	LIMIT-4	Emergency stop
14	Relay control	
15	NC	Not connect
16	STEPB-	B (4th axis) pulse signal
17	DIRB-	B(4th axis) direction signal
18-25	GND	

VI.The extend connection of 4th axis

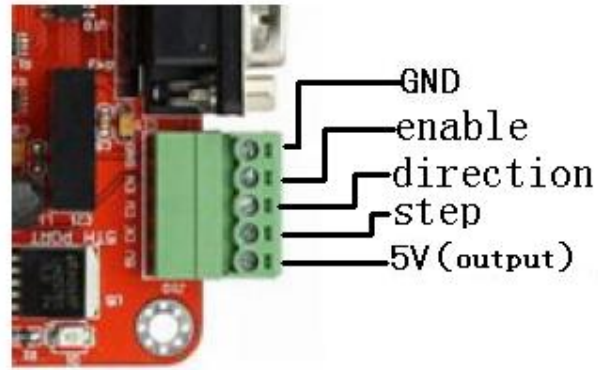
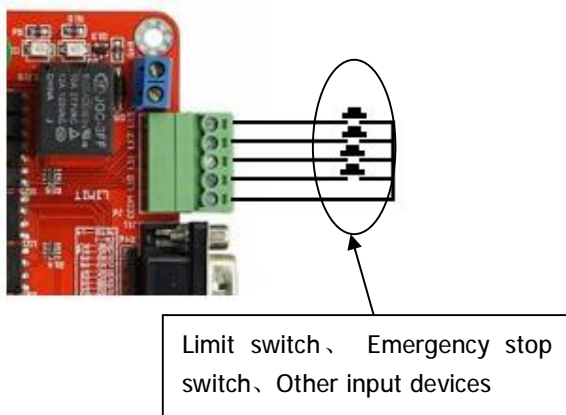

Fig.3

VII.Limit switch connection



VIII. Adjusting current decay、microstep resolution、current output

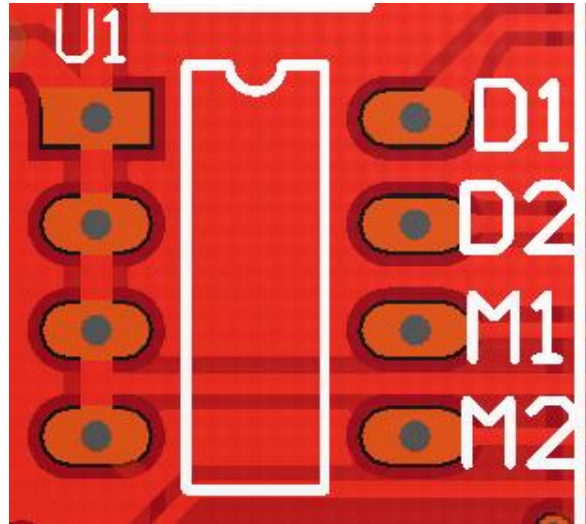

Fig.5

1. Current decay adjustment

The D1D2 are switches on the panel to set the current decay value

DIP switch on of two D1D2: D1/D2:

ON/ON——100%; ON/OF——25%;

OF/ON——50%; OF/OF——0%;

DIP D1	DIP D2	Mode
ON	ON	Fast decay
OF	ON	50% fast decay
ON	OF	25% fast decay
OFF	OFF	Slow decay

Q: What are the specific role of the current decay of stepper motor driver board?

A: Subdivision is now the current subdivision of stepping motor. The phase current according to the sinusoidal tangent the current point as a basic point subdivision.when phase current reaches the subdivision that through to control current to control decay.Otherwise, if angle overshoot will occur, can not be stuck in sub-angle. Different modes of decay depends on different in speed of motor. Fast decay at high speed, low decay at low speed,Slow decay occurs vibration, noise, when high-speed.In severe cases, will lead to position not allowed,when we select low speed motor to faster decay. Motor Control IC for the current decay of the H bridge is the control mode switch.The high side of the tube when the slow decay off, fast decay tube are closed when the high and low side.Mixed decay is the fast decay and then a slow decay, mixing ratio of decay and power for the chip also will be different.

2.Subdivision regulation

DIP switches on the M1, M2 two to adjust, driver board subdivision may be adjustable,DIP switch The correspondence location and mode of between segments as follows:

DIP M1	DIP M2	Subdivision mode
ON	ON	1/8
OFF	ON	1/16
ON	OFF	1/2
OFF	OFF	1

To make the motor run smoothly, please try to choose high segments, such as 1 / 16 segments

3、Current setting

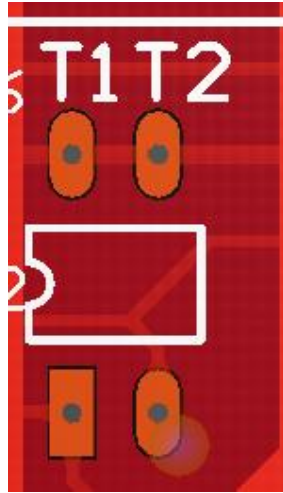

Fig.6

Current regulation is by the panel to T1T2 two DIP switches to control .Figure XYZA current regulation identifies the location of the 2-way DIP switch

Dip T1	Dip T2	Value of current
ON	ON	20%*2.5A
OFF	ON	50%*2.5A
ON	OFF	75%*2.5A
OFF	OFF	100%*2.5A

Proposed stepper motor current as close as possible the rated current

IX. stepper motor Connection

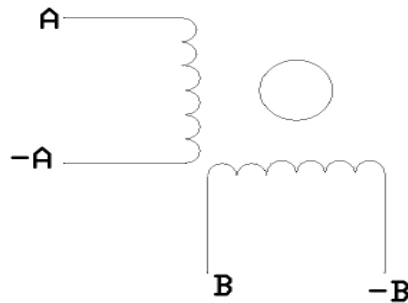

Four-wire stepper motor connection

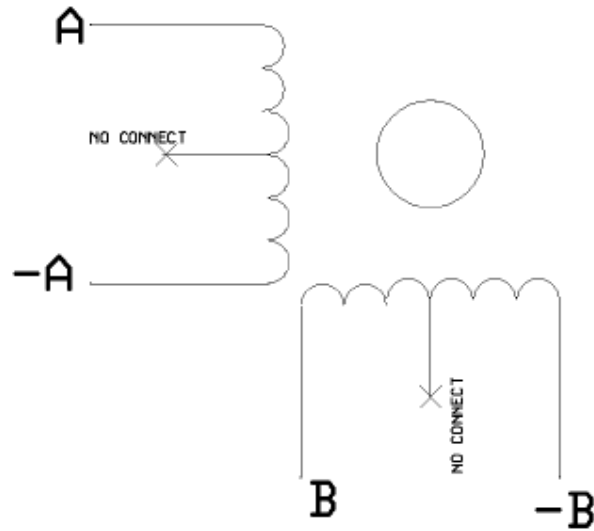

Fig 8 Six-wire stepper motor connection

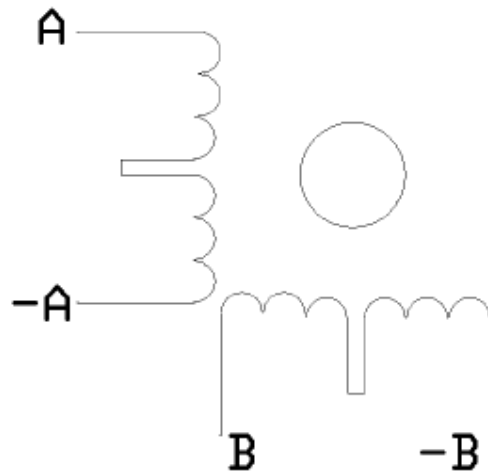

Fig 9 eight-wire stepper motor connection

Notes:Motor A+,A-, B+,B-, connected respectively, connected driver board AP, AM, BP, BM , Ensure that the connection is correct, Otherwise it will damage the chip !!

X .The choice of stepper motors and its power

The panel of **IFS-6560T3-N** axis match with two and four-phase motor drive of

domestic and foreign manufacturers , in order to obtain the most satisfactory results, need to set a reasonable supply voltage and current. The high-speed performance depends on the degree of the motor supply voltage.but the current set value determines the output torque of the motor.

A.Setting supply volatage

In general, when the higher the supply voltage, more great torque at the motor high speed, and avoid the motor out of step at high speed. On the other hand, the voltage too high may damage the drive, and work in high-voltage,vibratory at low speed
Reference value of power between 24-36VDC 6A

B.Setting output current

The larger of setting current, the greater of output torque in the same motor. But the problem is the larger current the more heat of motor and driver. So in general,we set the value at when it warm but not too hot to run at long-term.

- ⌌ AT high speed mode of 4 and 6-wire: the output current equal or less rated value
- ⌌ Larger torque mode of 6-wire: output current is 70%of rated value.
- ⌌ Tandem-type connection of 8-wire:output current is 70%of rated value
- ⌌ Parallel connection of 8-wire:output current is 1.4times of rated value.



图 3. 电机接线

Fig.10 the diagram of motor

XI、 Usage of MACH3

1、 Startup Mach3

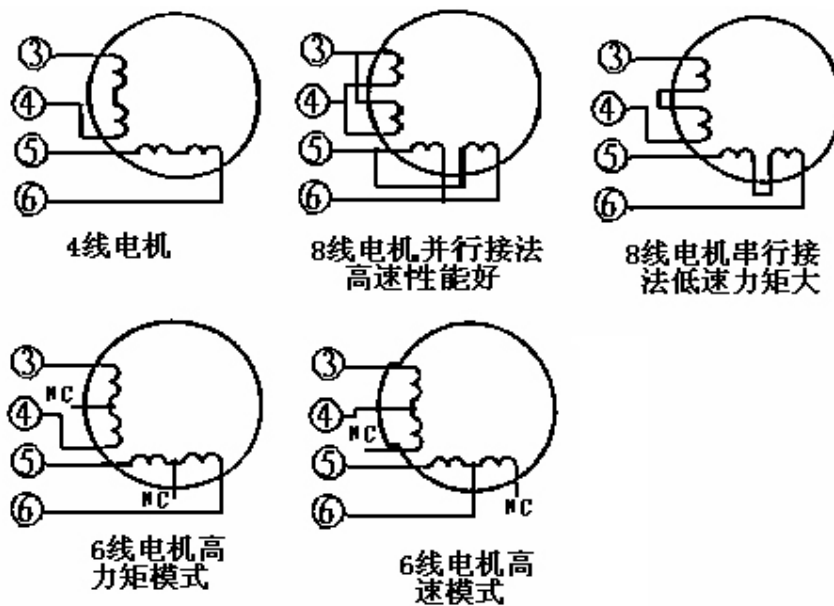

Fig 11 open mach3

When you have installed the software, here are 3 icons on the desk,let's click the march3Mill, as fig 11.

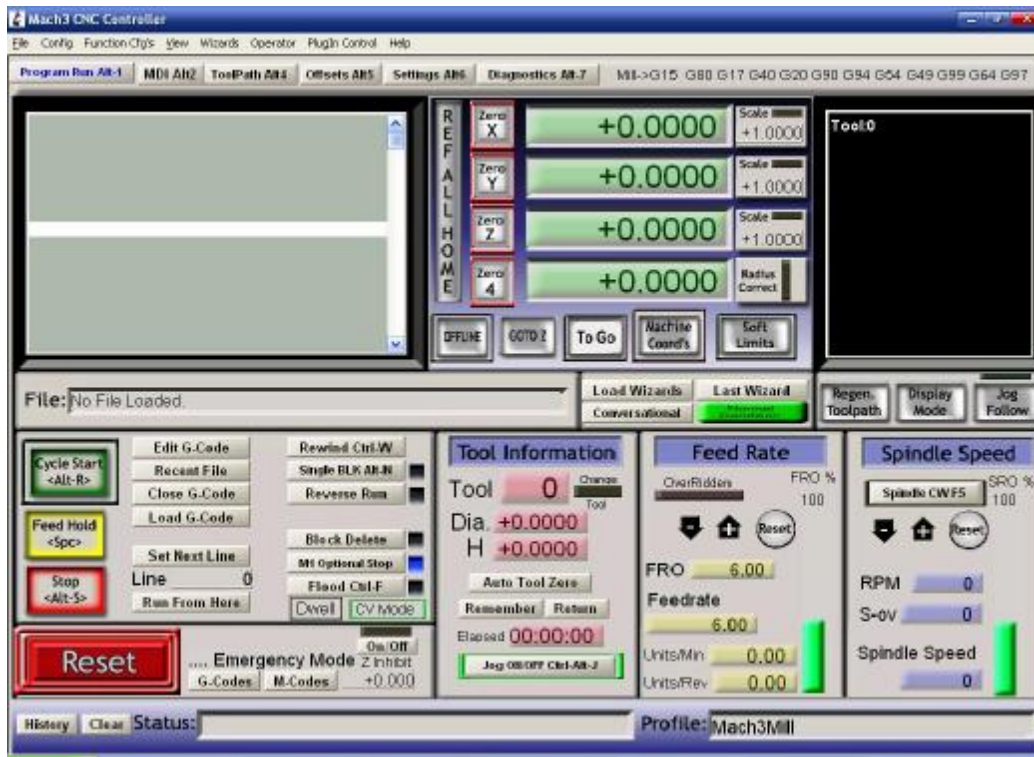

Fig 12 the main interface of march3

ST6560-T3 3axis mach3 cnc Stepper Motor Controller operation instruction

The main interface of MACH3 as fig 12 , some basic buttons on it,Here, we first configure MACH3.

2、 The basic set of mach3

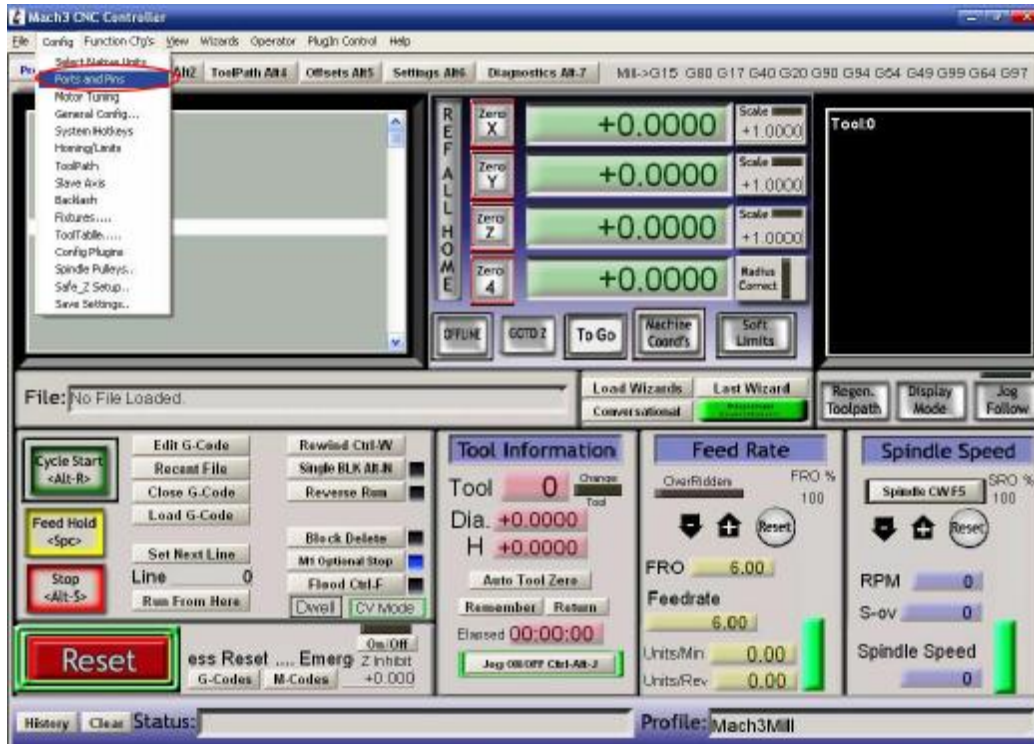

Fig 13 set menu of mach3

Open the config menu, ports and pins menu, marked with red circlet

ST6560-T3 3axis mach3 cnc Stepper Motor Controller operation instruction

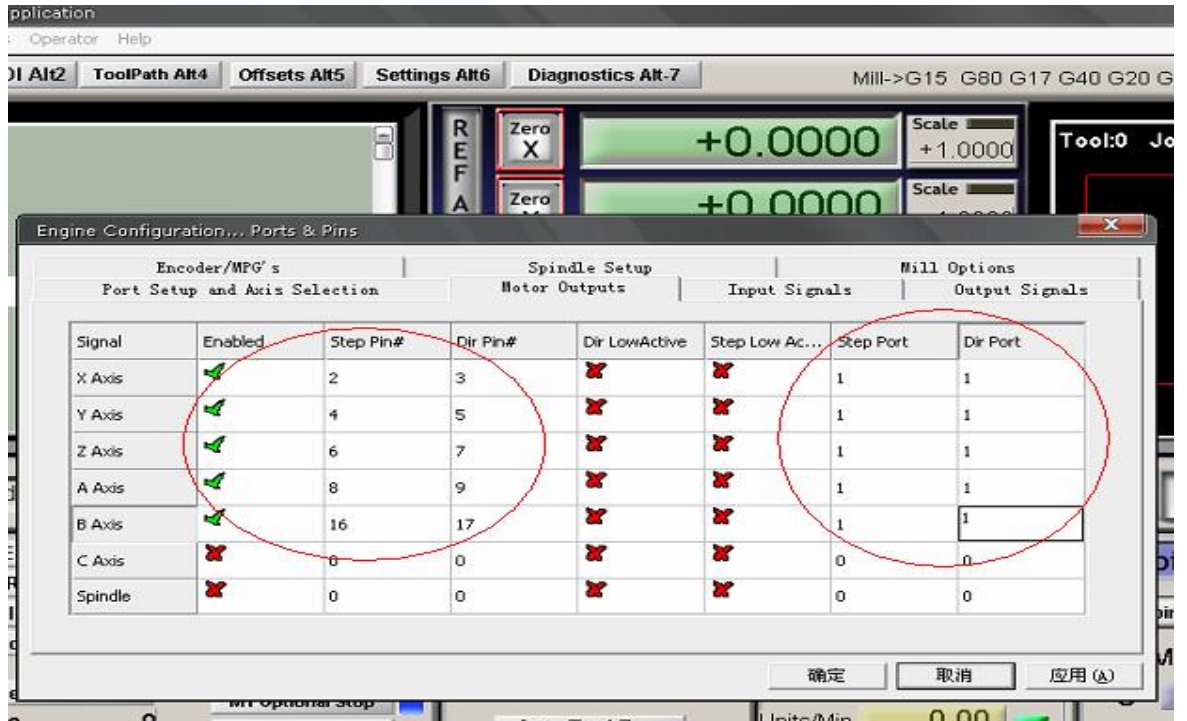
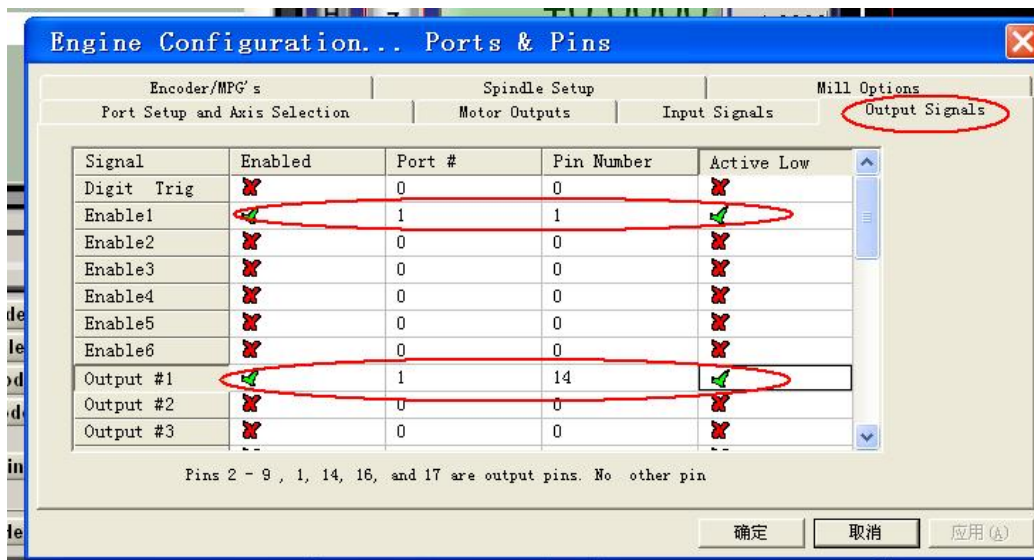

Fig 15 basic setting of direction and pulse pins

When you finished the setting, click output signals then set ENABLE and Relay



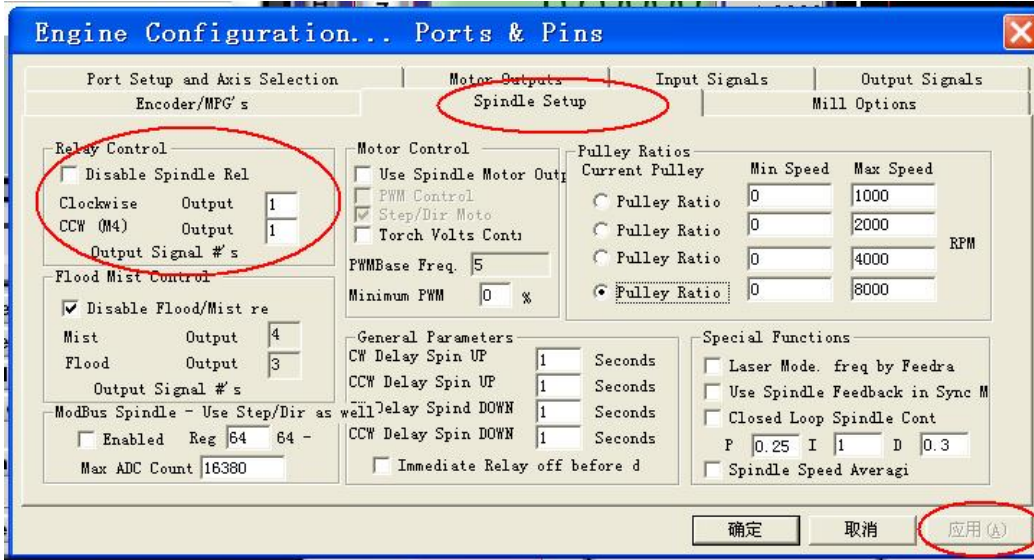
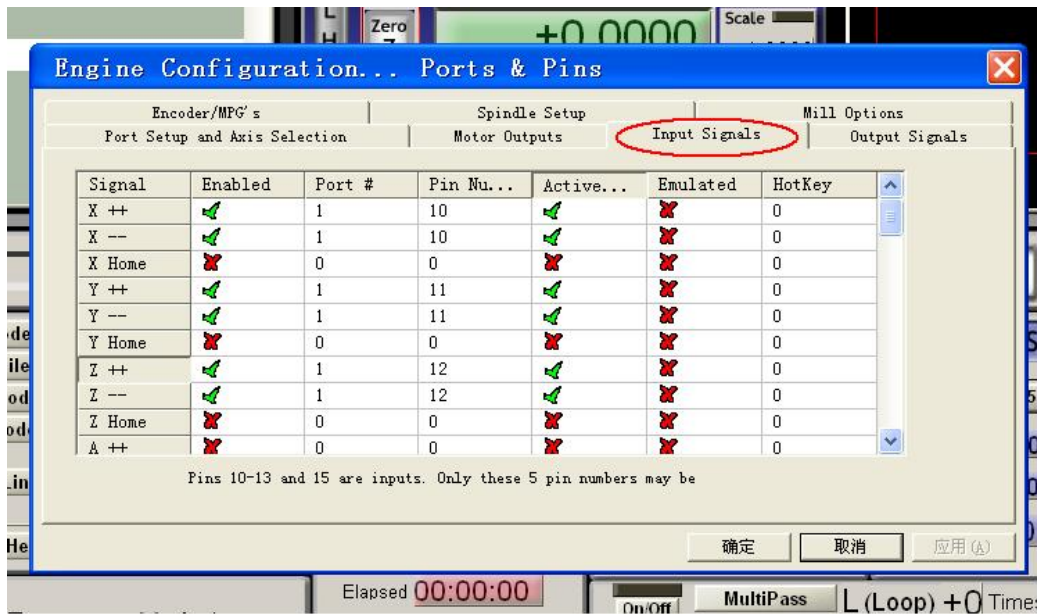

Fig 16 setting the ENABLE and Relay's pin

3、Adjusting limits witch of mach3

Click *input signal*, the parameter as fig17



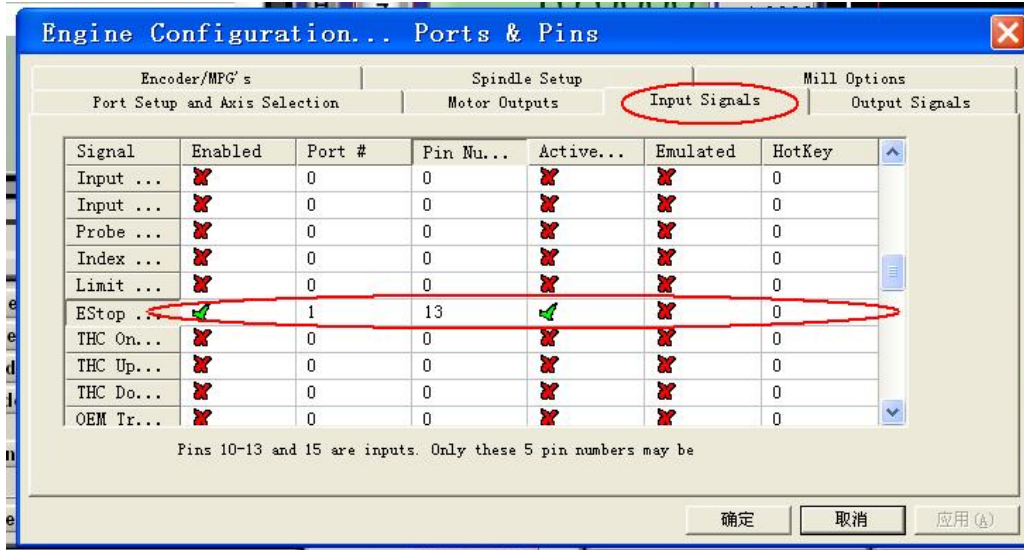

Fig 17

4、Running of G code

G is the numerical instructions control program code , mach3 for customers to test software comes with the G code, you can easily test machine.click the File, as fig 18

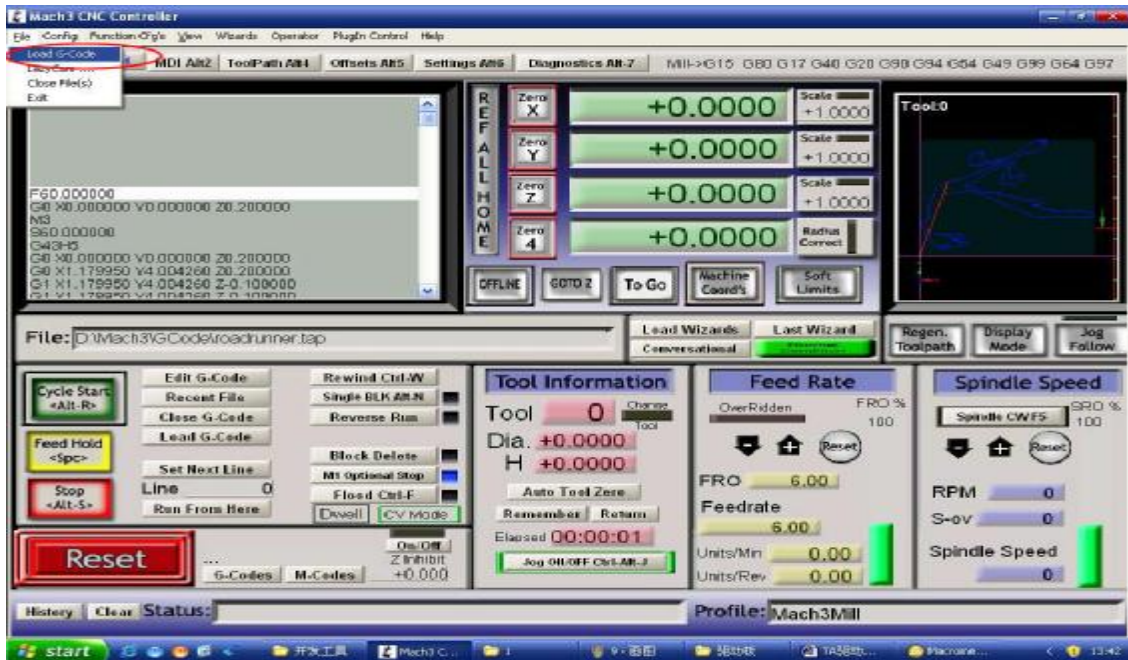



Fig 18 Open G

Click the red circlet **Load G-code** and open the icon  Mach3 and click

ST6560-T3 3axis mach3 cnc Stepper Motor Controller operation instruction

📁 GCode ,and choice a G code, the interface as follows as fig 19

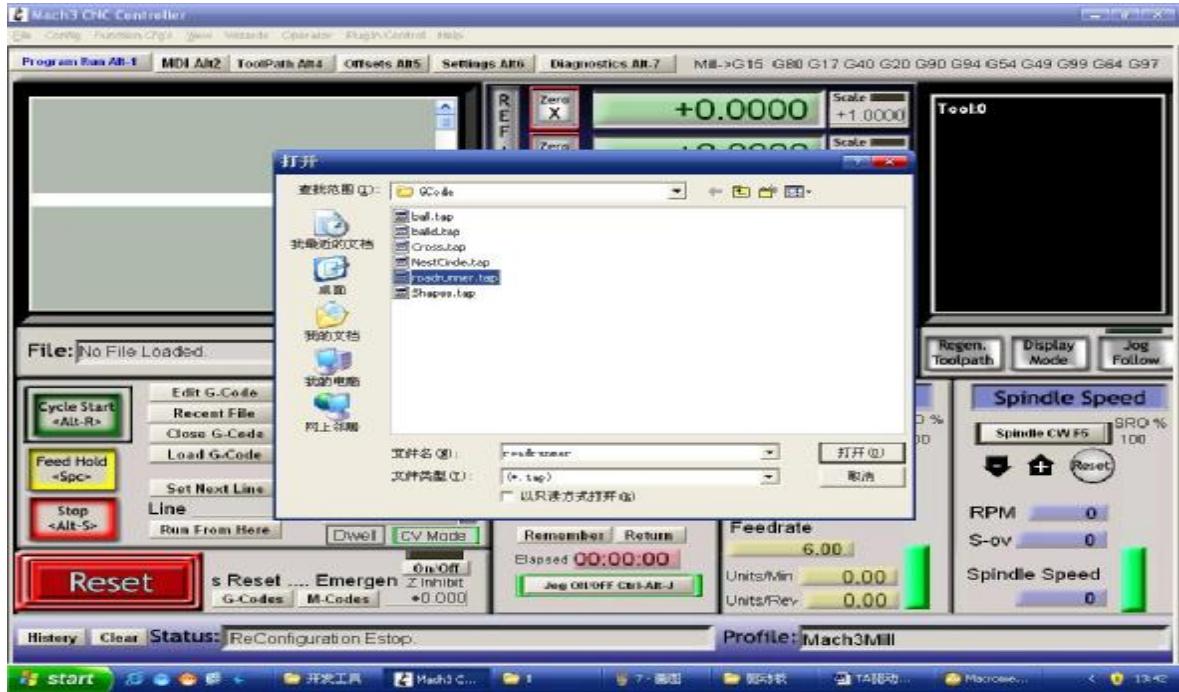

Fig 19 Open the testing procedures of G

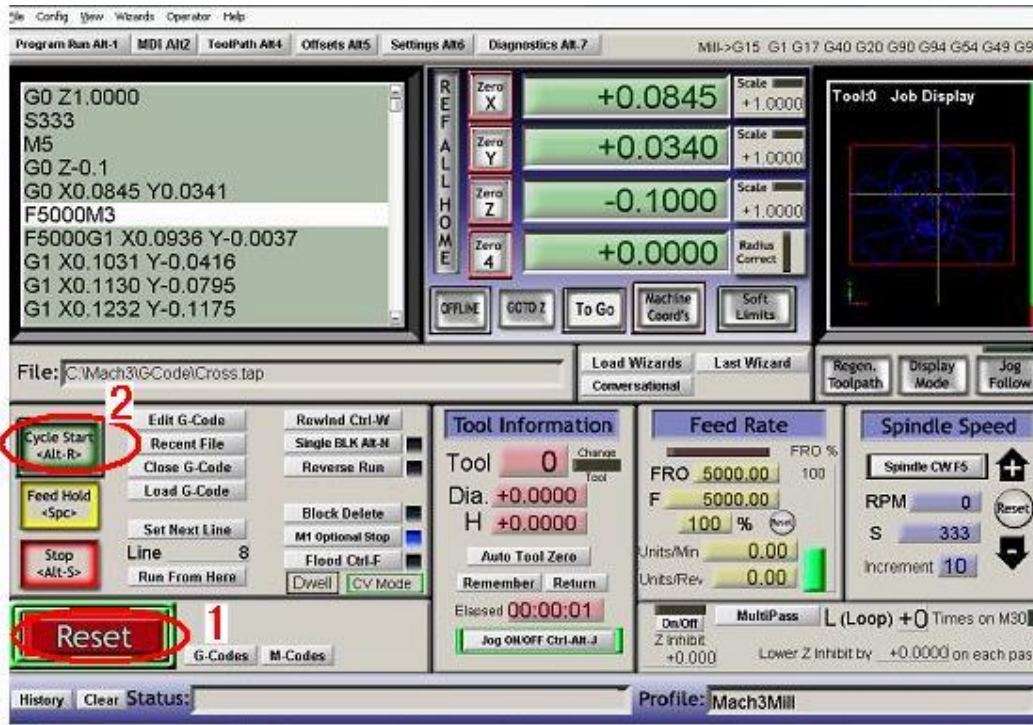

Fig 20

When you open the G code, you may watch on a flashing red button **RESET**,

ST6560-T3 3axis mach3 cnc Stepper Motor Controller operation instruction

click it to stop, and click the **CYCLESTART**.

If you want to run your own G code for processing.find your location of G code, and leading it in. ,

5、 How to use the manual control interface of MACH3

If you want manual control, press the keyboard “TAB” as follows as :

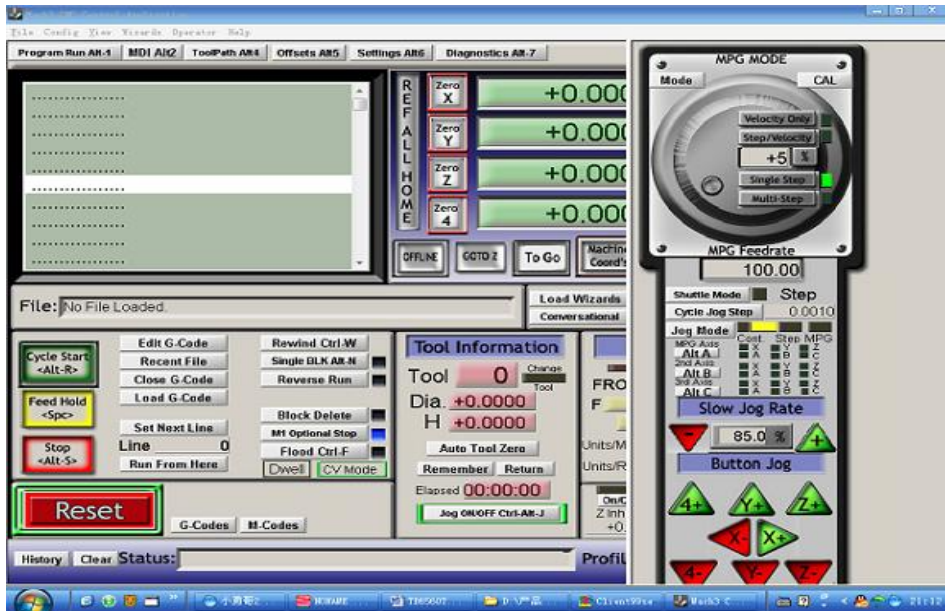

Fig21